



# Service Manual



PLACE SERIAL NUMBER LABEL HERE

# FACTORY CONTACT INFORMATION



BAY TEK GAMES INC.  
Pulaski Industrial Park  
1077 East Glenbrook Drive  
Pulaski, WI 54162 U.S.A.  
[www.baytekgames.com](http://www.baytekgames.com)

*Our Vision:*

*We aspire to be the best in the world at developing and manufacturing coin operated games for our customers.*

**JOIN SERVICE FIRST NETWORK!**

This free service is intended to keep you up to date on the latest game information, early notification of parts specials, pertinent technical bulletins, updates on retro fit parts, software upgrades, & much more. Log on to:  
[www.baytekgames.com/parts](http://www.baytekgames.com/parts)  
& then click on the Service First icon.

8 AM - 5 PM C.S.T. MON - FRI



**SALES**

P: 920.822.3951  
F: 920.822.8936  
[sales@baytekgames.com](mailto:sales@baytekgames.com)

**PARTS**

P: 920.822.3951 x 1101  
F: 920.822.1496  
[parts@baytekgames.com](mailto:parts@baytekgames.com)

**SERVICE:**

P: 920.822.3951 X 1102  
F: 920.822.1496  
[service@baytekgames.com](mailto:service@baytekgames.com)

All games proudly manufactured at our factory in Pulaski, Wisconsin U.S.A.

# TABLE OF CONTENTS

|                               |       |
|-------------------------------|-------|
| FACTORY CONTACT INFORMATION   | 2     |
| WELCOME TO: CRANK IT!         | 4     |
| HOW TO PLAY                   | 5     |
| SPECIFICATIONS                | 6     |
| SAFETY PRECAUTIONS            | 6     |
| DIP SWITCH SETTINGS           | 7     |
| MAIN MENU FUNCTIONS           | 8     |
| CREDITS PER PLAY              | 9     |
| TICKET PATTERNS               | 9-11  |
| GAME VOLUME                   | 12    |
| ATTRACT MODE VOLUME           | 12    |
| GOOD SPIN WHEEL SPEED SELECT  | 12    |
| WHEEL POSITION DIAGNOSTICS    | 13    |
| TICKET VALUE DIAGNOSTICS      | 14    |
| MAINBOARD WIRING              | 15    |
| CABLE DIAGRAMS                | 16-18 |
| TROUBLESHOOTING GUIDE         | 19-22 |
| POWER SUPPLY DIAGNOSTICS      | 23    |
| BILL ACCEPTOR DIAGNOSTICS     | 24    |
| HOW TO: CHANGE ARROW POSITION | 25    |
| HOW TO: ADJUST WHEEL SENSOR   | 26    |
| HOW TO: SET BRAKE TENSION     | 27    |
| HOW TO: CHANGE TICKET PATTERN | 28    |
| HOW TO: REMOVE WHEEL          | 29-30 |
| HOW TO: CLEAN GAME            | 31    |
| PARTS LISTS                   | 32-35 |
| MAINBOARD PINOUT              | 36-38 |
| MAINTENANCE LOG               | 39    |
| TECHNICAL SUPPORT             | 40    |
| WARRANTY                      | 41    |
| CE COMPLIANCE CERTIFICATE     | 42    |

# WELCOME TO: CRANK IT!

Step up and CRANK IT!

This bright and exciting game really gets the gears turning! With fun, colorful graphics, attractive LED lighting, dot-matrix display, and a goofy, infectious audio package, Crank It is sure to entertain the little, the big, and everyone in between!

Lift up and push down the handle to spin the wheel. Boogie to the funky beat as you wait for the wheel to stop, and win tickets according to where the arrow is pointing!

Please take a moment to read through this manual and be sure to contact our factory if you have any questions, or would like some more information.

Thank you for your purchase! Your business is important to us and we hope you enjoy this game as much as we do!

*Your Friends at Bay Tek Games*



## GAME INSPECTION

Inspect the game for any damaged, loose, or missing parts. If damage is found, please contact your freight carrier first. Then, contact Bay Tek Games Service Department at 920.822.3951 or e-mail them at [service@baytekgames.com](mailto:service@baytekgames.com) for further assistance.

# HOW TO PLAY

**Crank it up...**



**Crank it down...**



**Watch the wheel spin 'round  
and 'round!**



**Land the arrow on a space...**



**And put a smile on your face!**

**Win BIG with Crank It!**



# SPECIFICATIONS

| WEIGHT      |          |
|-------------|----------|
| WEIGHT      | 675 lbs. |
| SHIP WEIGHT | 755 lbs. |

| DIMENSIONS |        |
|------------|--------|
| WIDTH      | 30     |
| DEPTH      | 39.25" |
| HEIGHT     | 82"    |











| OPERATING TEMPERATURE |            |
|-----------------------|------------|
| 80 - 100 Degrees      | Fahrenheit |
| 26.7 - 37.8 Degrees   | Celsius    |

| POWER REQUIREMENTS    |                |    |                |
|-----------------------|----------------|----|----------------|
| INPUT VOLTAGE RANGE   | 100 to 120 VAC | or | 220 to 240 VAC |
| INPUT FREQUENCY RANGE | 50 HZ          | to | 60 HZ          |

| MAX START UP CURRENT |
|----------------------|
| 1.5 AMPS @ 115 VAC   |
| 0.75 AMPS @ 230 VAC  |

| OPERATING CURRENT  |
|--------------------|
| 0.7 AMPS @ 115 VAC |
| .35 AMPS @ 230 VAC |

# SAFETY PRECAUTIONS

|   |
|---|
|  <b>DANGER</b>    |
| DO NOT perform repairs or maintenance on this game with the power ON. Unplug the unit from the wall outlet or shut off the power at the power strip located inside the game cabinet.  |
|  <b>WARNING</b>   |
| Use of flammable substances can cause severe burns or serious injury. Always use NON-FLAMMABLE solvents for cleaning. DO NOT use gasoline, kerosene, or thinners.   |
|  <b>CAUTION</b>   |
| Lifting heavy objects can cause back, neck, or other injuries. Be sure adequate lifting and moving devices are available when unloading, unpacking, and moving this game.   |
|  <b>ATTENTION</b>   |
| Be sure the electrical power matches the game requirements. See the serial number decal located on the back of the game cabinet. Always plug game into a grounded circuit. If the supply cord is damaged, it must be replaced by a special cord or assembly available from the manufacturer or its service agent. |
|  <b>IN CASE OF EMERGENCY:</b>   |
| <b>Unplug the power cord.</b><br>The power cord must be accessible <u>at all times</u> in case of emergency.  |

# DIP SWITCH SETTINGS

The dip switch bank is located on the main board, inside the front door of the game.

\*factory default settings are highlighted in blue

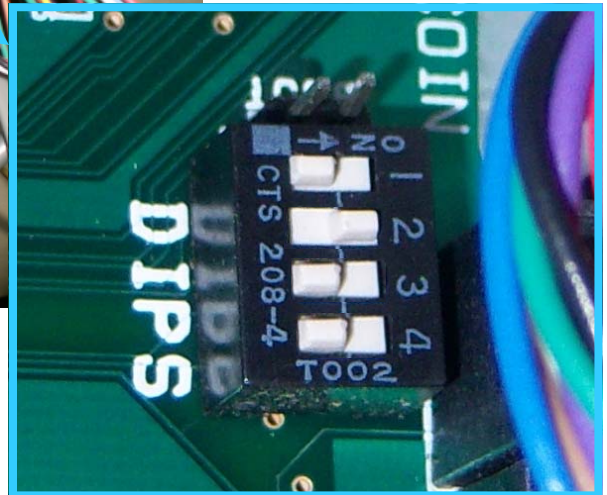
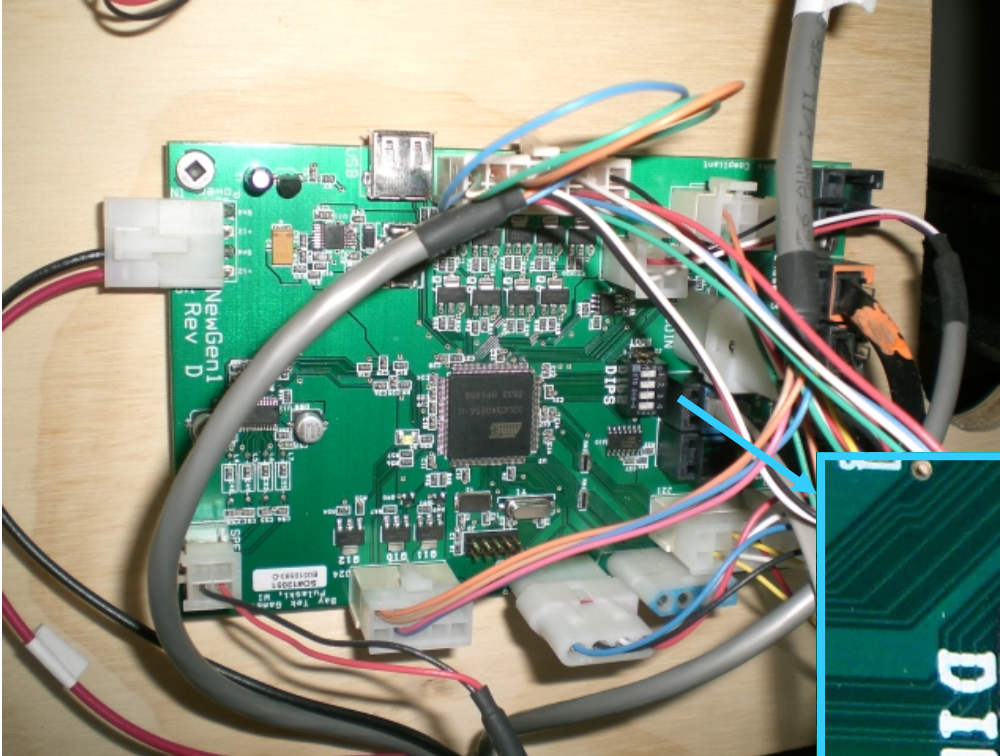

| SWITCH | ON                       | OFF                           |
|--------|--------------------------|-------------------------------|
| 1      | Double-value tickets ON  | Double-value tickets OFF      |
| 2*     | Standard arrow position  | Lower “kiddie” arrow position |
| 3      | Jersey Shore settings ON | Jersey Shore settings OFF     |
| 4      | Brake Test ON            | Brake Test OFF                |

\* See page 25 to change arrow position

# DETAILED OPERATIONS

## MENUS

1. Press and hold the “MENU” button inside the front door of the cabinet for **3 seconds** to enter the menu
2. Tap the “MENU” button to scroll through the options
3. To choose an option, press the “SELECT” button
4. Scroll through the menu settings with the “SELECT” button
5. To make your selection, press the “MENU” button to scroll through the remaining menus past 6 to exit

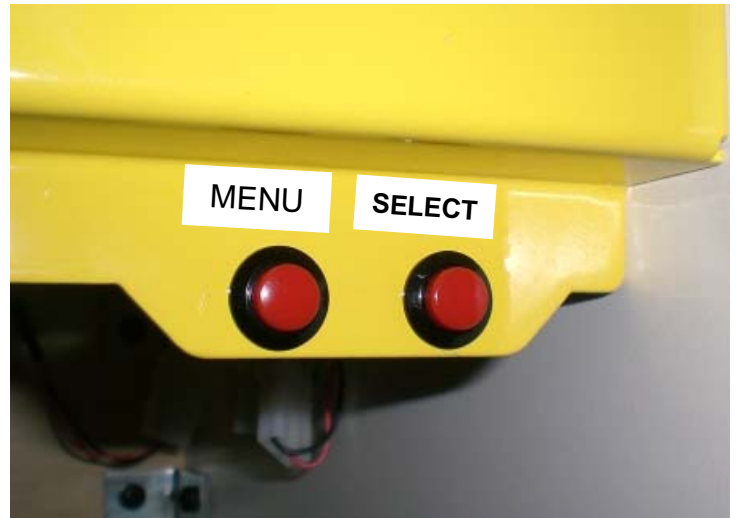

| MENU     | DESCRIPTION                |
|----------|----------------------------|
| <b>1</b> | CREDITS PER PLAY           |
| <b>2</b> | TICKET PATTERNS            |
| <b>3</b> | GAME VOLUME                |
| <b>4</b> | ATTRACT MODE VOLUME        |
| <b>5</b> | GOOD SPIN WHEEL SPEED      |
| <b>6</b> | WHEEL POSITION DIAGNOSTICS |
| <b>7</b> | TICKET VALUE DIAGNOSTICS   |



# MENU 1– CREDITS PER PLAY

Scroll through the n1 menu with the “menu select” button.  
 Make your selection by pressing the “menu button” and scrolling  
 through the remaining menus past n6 to exit the menu.  
 \*Factory default settings are highlighted in BLUE.

|   |   |   |   |   |   |   |   |
|---|---|---|---|---|---|---|---|
| 1 | 2 | 3 | 4 | 5 | 6 | 7 | 8 |
|---|---|---|---|---|---|---|---|

# MENU 2– TICKET PATTERNS

Scroll through the n2 menu with the “menu select” button.  
 Make your selection by pressing the “menu button” and scrolling  
 through the remaining menus past n6 to exit the menu.  
 \*Factory default settings are highlighted in BLUE.

These settings should not be changed unless the decals on the game’s wheel are also changed.

We encourage you to try the thoroughly tested standard factory ticket pattern for at least a month before deciding to change it.

Please contact our Service Department to order replacement decals if you do decide to change the ticket pattern on your game.

## QUICK REFERENCE

| Ticket pattern:           | 1          | 2          | 3          | 4           | 5           | 6           | 7     | 8     |
|---------------------------|------------|------------|------------|-------------|-------------|-------------|-------|-------|
| Credits / Price per play: | 2<br>\$.50 | 2<br>\$.50 | 2<br>\$.50 | 4<br>\$1.00 | 4<br>\$1.00 | 4<br>\$1.00 | 1 cr. | 1 cr. |
| Bonus value               | 250        | 500        | 1000       | 500         | 1000        | 2000        | 50    | 100   |

# MENU 2- TICKET PATTERNS, cont.

| 1                      | 2                      | 3                      | 4                      | 5                      | 6                      | 7                    |
|------------------------|------------------------|------------------------|------------------------|------------------------|------------------------|----------------------|
| 50¢/250 bonus          | 50¢/500 bonus          | 50¢/1000 bonus         | \$1.00/500 bonus       | \$1.00/1000 bonus      | \$1.00/2000 bonus      |                      |
|                        |                        |                        |                        |                        |                        |                      |
| 16-19<br>Avg Tix/ Game | 17-20<br>Avg Tix/ Game | 16-19<br>Avg Tix/ Game | 33-36<br>Avg Tix/ Game | 34-37<br>Avg Tix/ Game | 35-38<br>Avg Tix/ Game | 3-5<br>Avg Tix/ Game |

# MENU 2– TICKET PATTERNS, cont.

| 8  | 9   | 10  | 11  | 12   | 13   | 14  |
|--|---|---|---|--|--|---|
| <p><b>2</b> <b>100</b> <b>2</b></p> <p><b>3</b> <b>5</b> <b>3</b></p> <p><b>20</b> <b>2</b> <b>2</b></p> <p><b>3</b> <b>5</b> <b>3</b></p> <p><b>20</b> <b>2</b> <b>2</b></p> <p><b>3</b> <b>5</b> <b>3</b></p> <p><b>20</b> <b>2</b> <b>2</b></p> <p><b>3</b> <b>5</b> <b>3</b></p> <p>seam</p> | <p><b>1</b> <b>100</b> <b>1</b></p> <p><b>2</b> <b>4</b> <b>2</b></p> <p>seam</p> <p><b>20</b> <b>1</b> <b>1</b></p> <p><b>2</b> <b>4</b> <b>2</b></p> <p><b>20</b> <b>1</b> <b>1</b></p> <p><b>2</b> <b>4</b> <b>2</b></p> <p><b>20</b> <b>1</b> <b>1</b></p> <p><b>2</b> <b>4</b> <b>2</b></p> <p><b>20</b> <b>1</b> <b>1</b></p> <p><b>2</b> <b>4</b> <b>2</b></p> | <p><b>1</b> Euro</p> <p><b>1000</b></p> <p><b>25</b> <b>100</b> <b>50</b></p> <p>seam</p> <p><b>250</b> <b>25</b> <b>100</b> <b>50</b></p> <p><b>25</b> <b>100</b> <b>50</b></p> <p><b>250</b> <b>25</b> <b>100</b> <b>50</b></p> <p><b>25</b> <b>100</b> <b>50</b></p> <p><b>250</b> <b>25</b> <b>100</b> <b>50</b></p> <p><b>25</b> <b>100</b> <b>50</b></p> <p><b>250</b> <b>25</b> <b>100</b> <b>50</b></p> <p><b>25</b> <b>100</b> <b>50</b></p> | <p><b>30 pence</b></p> <p><b>250</b> <b>10</b> <b>3</b> <b>5</b></p> <p><b>50</b> <b>10</b> <b>3</b> <b>5</b></p> <p><b>50</b> <b>10</b> <b>3</b> <b>5</b></p> <p><b>250</b> <b>10</b> <b>3</b> <b>5</b></p> <p><b>100</b> <b>10</b> <b>3</b> <b>5</b></p> <p><b>50</b> <b>10</b> <b>3</b> <b>5</b></p> | <p><b>40 pence</b></p> <p><b>250</b> <b>10</b> <b>3</b> <b>5</b></p> <p><b>100</b> <b>10</b> <b>3</b> <b>5</b></p> <p><b>100</b> <b>10</b> <b>3</b> <b>5</b></p> <p><b>100</b> <b>10</b> <b>3</b> <b>5</b></p> <p><b>250</b> <b>10</b> <b>3</b> <b>5</b></p> <p><b>100</b> <b>10</b> <b>3</b> <b>5</b></p> | <p><b>500</b> <b>5</b> <b>3</b> <b>5</b></p> <p><b>50</b> <b>5</b> <b>3</b> <b>5</b></p> <p><b>100</b> <b>5</b> <b>3</b> <b>5</b></p> <p><b>50</b> <b>5</b> <b>3</b> <b>5</b></p> <p><b>50</b> <b>5</b> <b>3</b> <b>5</b></p> <p><b>50</b> <b>5</b> <b>3</b> <b>5</b></p> <p><b>50</b> <b>5</b> <b>3</b> <b>5</b></p> <p>↑</p> | <p><b>FIXED PATTERN</b></p> <p><b>4</b> <b>4</b> <b>4</b> <b>4</b></p> <p><b>4</b> <b>4</b> <b>4</b> <b>4</b></p> <p><b>4</b> <b>4</b> <b>4</b> <b>4</b></p> <p><b>4</b> <b>4</b> <b>4</b> <b>4</b></p> <p><b>4</b> <b>4</b> <b>4</b> <b>4</b></p> <p><b>4</b> <b>4</b> <b>4</b> <b>4</b></p> <p><b>4</b> <b>4</b> <b>4</b> <b>4</b></p> <p><b>4</b> <b>4</b> <b>4</b> <b>4</b></p> <p><b>4</b> <b>4</b> <b>4</b> <b>4</b></p> <p><b>4</b> <b>4</b> <b>4</b> <b>4</b></p> <p><b>4</b> <b>4</b> <b>4</b> <b>4</b></p> <p><b>4</b> <b>4</b> <b>4</b> <b>4</b></p> <p><b>4</b> <b>4</b> <b>4</b> <b>4</b></p> <p><b>4</b> <b>4</b> <b>4</b> <b>4</b></p> <p><b>4</b> <b>4</b> <b>4</b> <b>4</b></p> <p><b>4</b> <b>4</b> <b>4</b> <b>4</b></p> |
| <b>3-5</b><br>Avg Tix/ Game  | <b>2-4</b><br>Avg Tix/ Game   | <b>60-66</b><br>Avg Tix/ Game   | <b>8-12</b><br>Avg Tix/ Game  | <b>10-13</b><br>Avg Tix/ Game  | <b>11-14</b><br>Avg Tix/ Game  | <b>11-14</b><br>Avg Tix/ Game   |

## MENU 3– GAME VOLUME

Scroll through the n3 menu with the “menu select” button.  
Make your selection by pressing the “menu button” and scrolling  
through the remaining menus past n6 to exit the menu.

**\*Factory default settings are highlighted in BLUE.**

|            |   |   |   |   |   |   |   |
|------------|---|---|---|---|---|---|---|
| 0<br>(OFF) | 1 | 2 | 3 | 4 | 5 | 6 | 7 |
|------------|---|---|---|---|---|---|---|

This control is for the volume of the game **while it is being played**,  
or after a coin has been inserted.

A sample noise will play an example volume while scrolling through  
the volume levels.

## MENU 4– ATTRACT VOLUME

Scroll through the n4 menu with the “menu select” button.  
Make your selection by pressing the “menu button” and scrolling  
through the remaining menus past n6 to exit the menu.

**\*Factory default settings are highlighted in BLUE.**

|            |   |   |   |   |   |   |   |
|------------|---|---|---|---|---|---|---|
| 0<br>(OFF) | 1 | 2 | 3 | 4 | 5 | 6 | 7 |
|------------|---|---|---|---|---|---|---|

This control is for the volume of the game  
**while it is NOT being played.**

This game plays fun sounds to lure customers to play.  
A sample noise will play an example volume while scrolling through  
the volume levels.

## MENU 5– GOOD SPIN SPEED SELECT

Scroll through the n4 menu with the “menu select” button.  
Make your selection by pressing the “menu button” and scrolling  
through the remaining menus past n6 to exit the menu.

**\*Factory default settings are highlighted in BLUE.**

|                |   |   |                |
|----------------|---|---|----------------|
| 1<br>(fastest) | 2 | 3 | 4<br>(slowest) |
|----------------|---|---|----------------|

# MENU 6– WHEEL POSITION DIAGNOSTICS

While in wheel position diagnostics, turn the wheel down towards you to view the position of each space on the wheel.  
The count should start at 0 on the decal seam, and count up to 24.

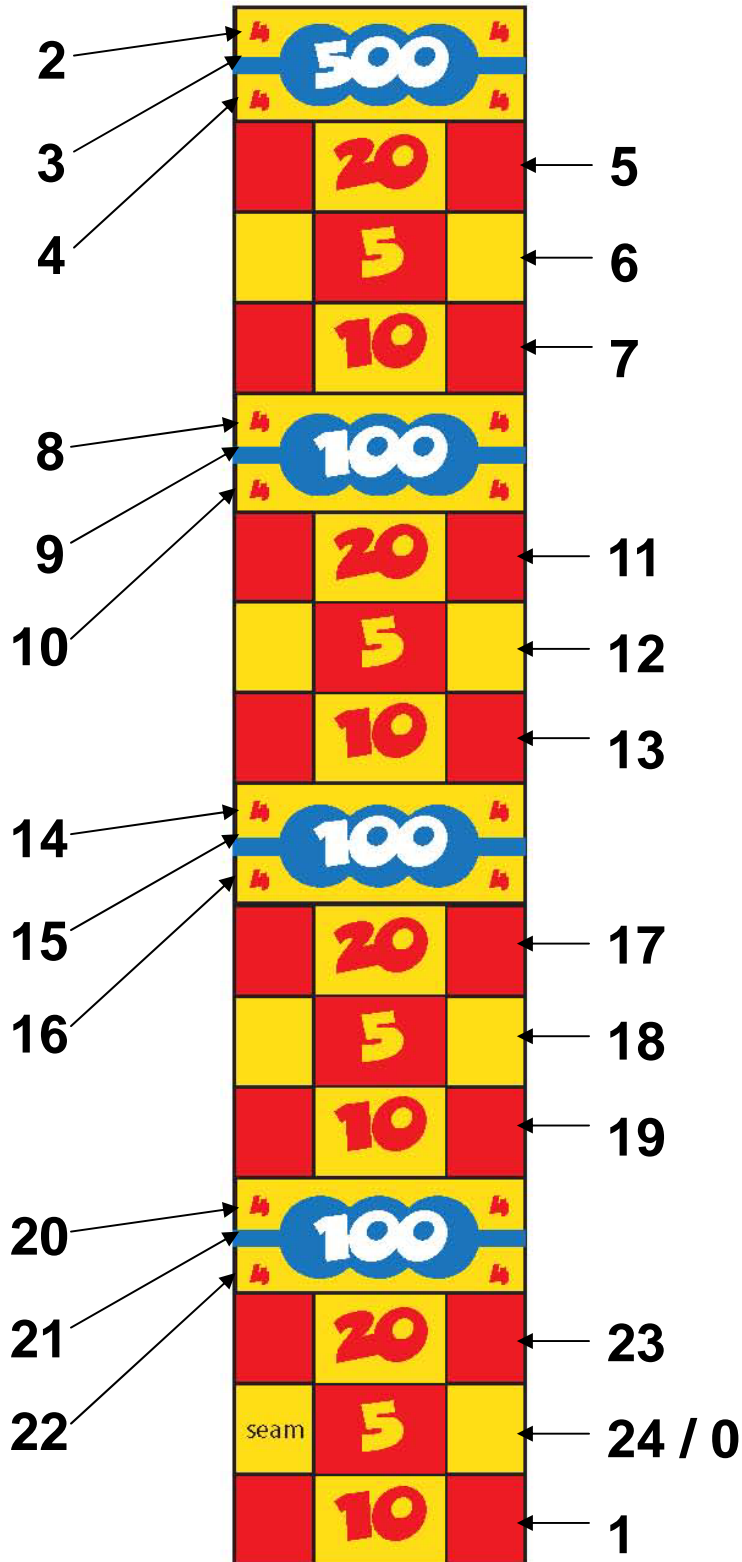

# MENU 7– TICKET VALUE DIAGNOSTICS

While in ticket value diagnostics, the dot-matrix display should show the same number as the wheel as you turn it towards you.



# CIRCUIT BOARD WIRING

## AANEWGEN1 - MAIN BOARD

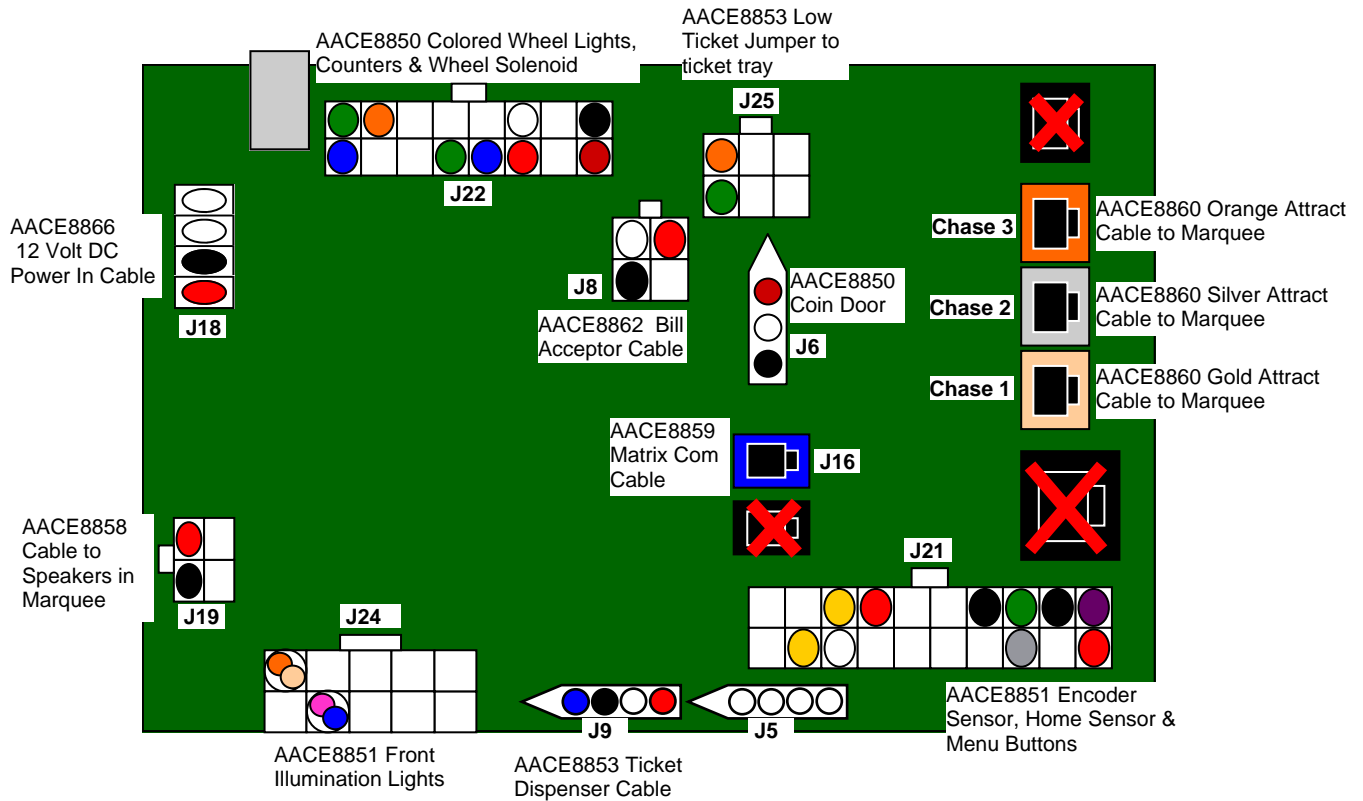

# Coin Door and Bill Acceptor Cable

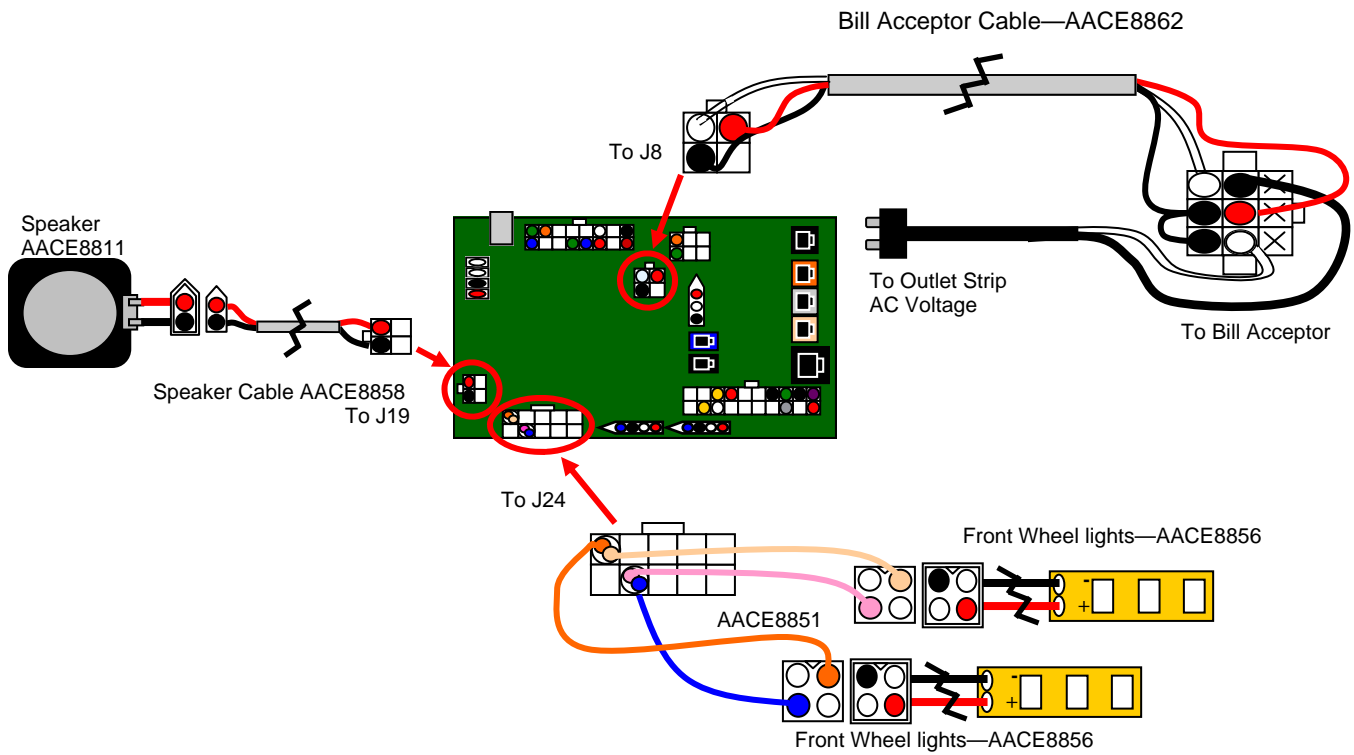

# Ticket Dispenser / Low Ticket Switches

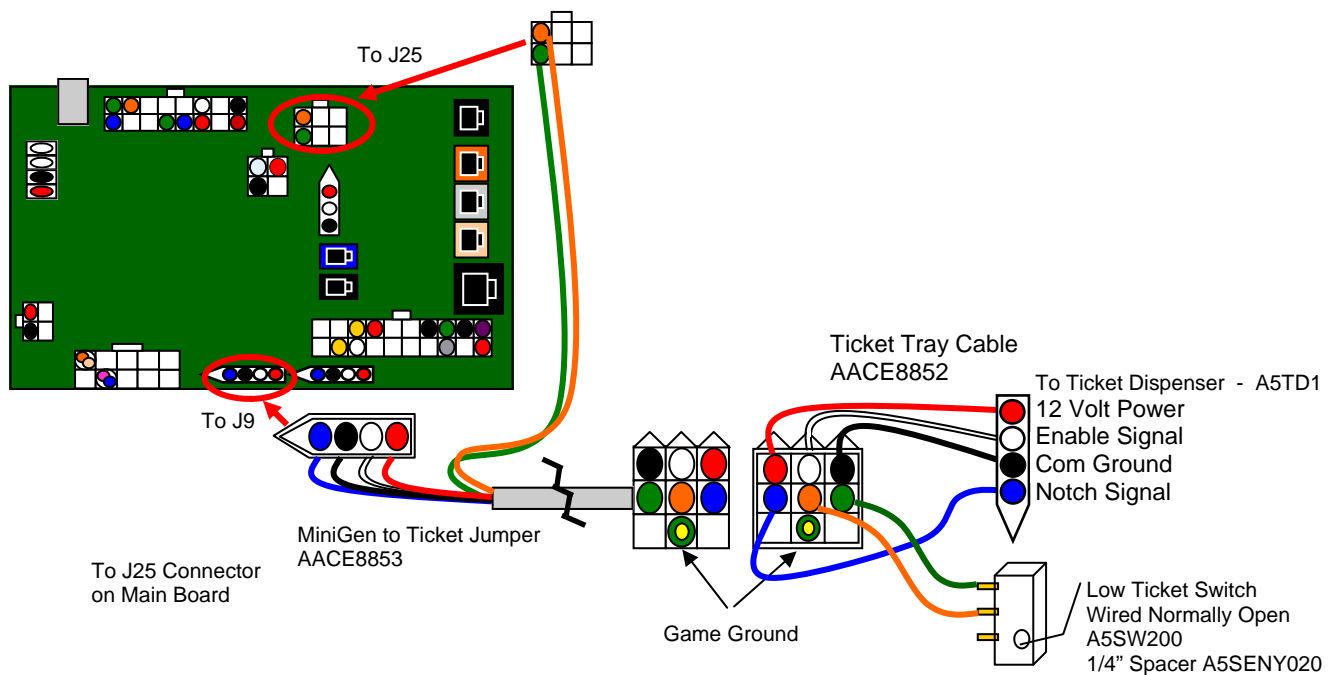



# Sensors, Menu Buttons, & Wheel Solenoid

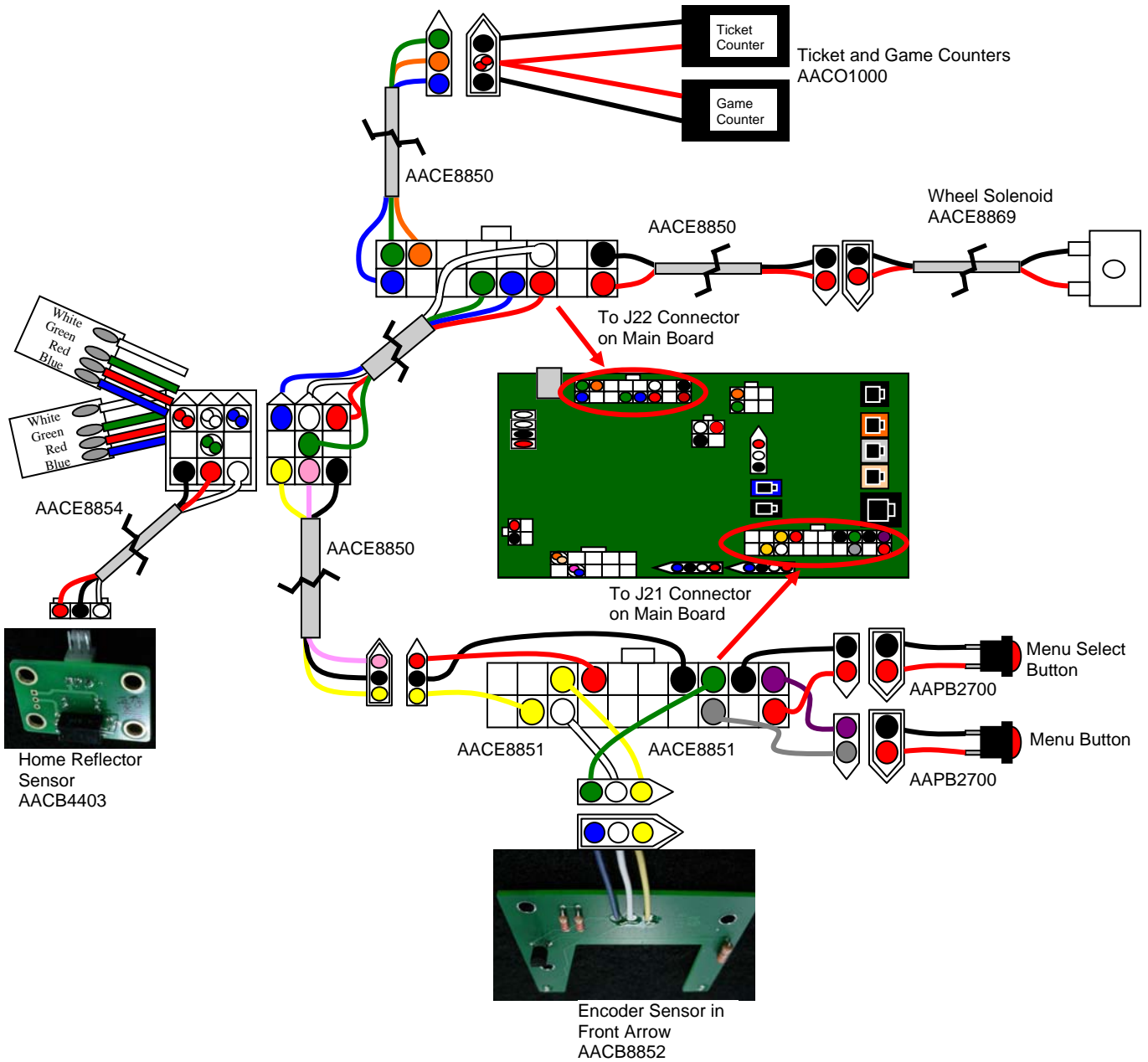

# Marquee & Power Supply Wiring

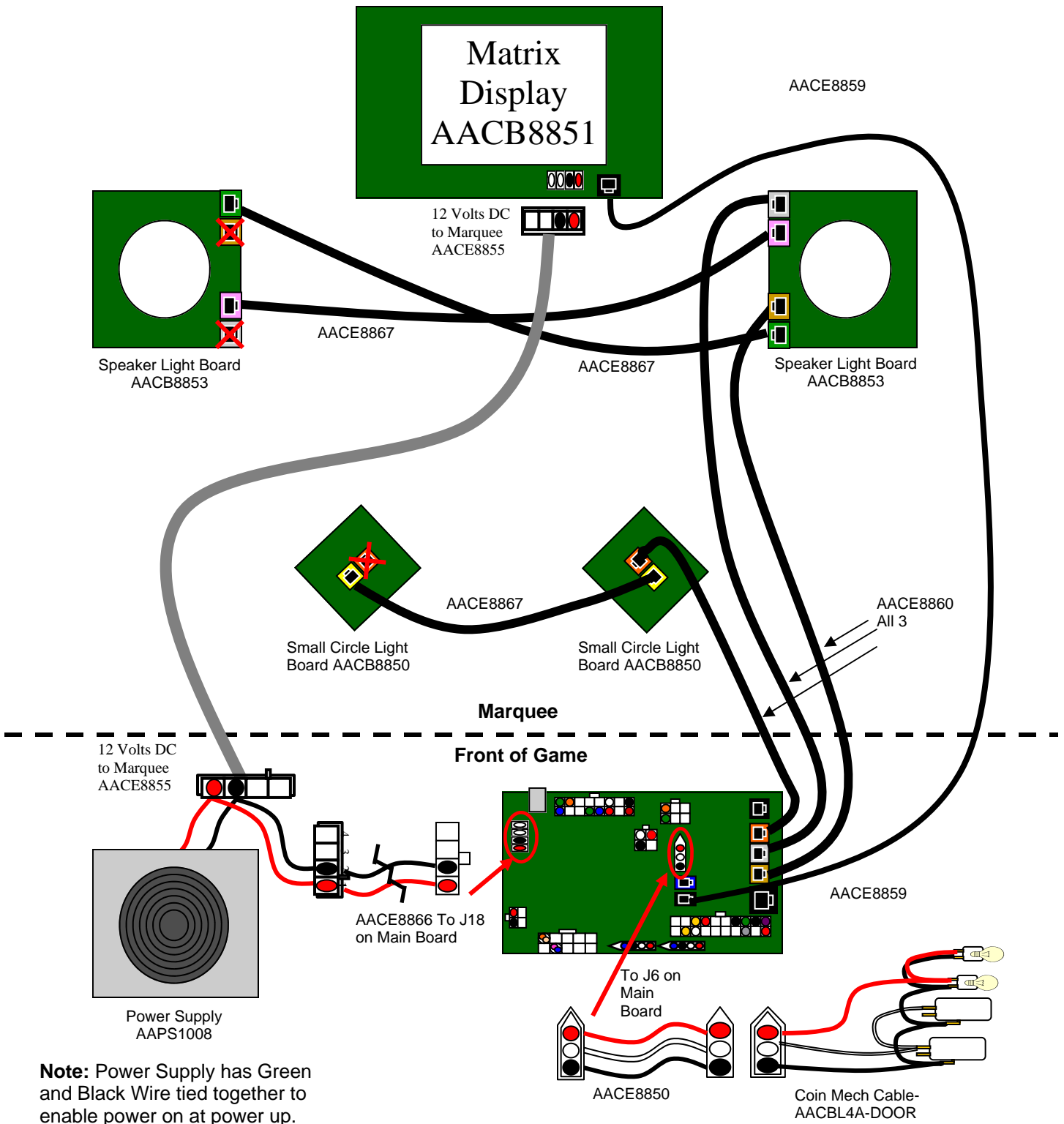

# TROUBLE SHOOTING GUIDE



## Troubleshooting Strategy

Use common sense and a systematic method of troubleshooting to determine the exact problem, probable cause and remedy. Use the process of elimination to find the faulty component. Always check for the simple and obvious causes first such as unplugged, loose or broken wires and bad sensors, bent, pinched, stuck or jammed components.

### Troubleshooting Chart

| Problem   | Probable Cause   | Remedy   |
|---|--|--|
| <p><b>No power to the game.</b><br/><b>No lights on at all.</b></p>                                       | <p>Unplugged.</p> <p>Circuit breaker tripped.</p> <p>Power strip faulty.</p> <p>Faulty cable/power supply.</p>   | <p>Check wall outlet.</p> <p>Reset power strip breaker switch or building circuit breaker.</p> <p>Change plug position, replace if needed.</p> <p>See Power Supply diagnostic below.</p>   |
| <p><b>AC Light and Bill Acceptor on; everything else off.</b></p> <p><b>(Power Supply not ON)</b></p>     | <p>Power supply unplugged.</p> <p>Rocker Switch turned off.</p> <p>Power supply shutting down because of 12 V overload.</p> <p>Faulty power supply.</p>        | <p>Ensure unit is plugged into power strip.</p> <p>Make sure rocker switch is set to ON.</p>  <p>See power supply diagnostics to isolate bad component. A bad motor or 12 volt short would cause this.</p> <p>See Power Supply Diagnostic below.</p>  |
| <p><b>Dollar Bill Acceptor not functioning.</b></p> <p>Ensure Bill Acceptor is set to "Always Enable"</p> | <p>Check for power to Bill Acceptor.</p> <p>Dirt or debris in acceptor slot.</p> <p>Pinched, broken, or disconnected wiring.</p> <p>Bill acceptor problem.</p> | <p>Acceptor should cycle stacker at game power up. If not, check cable connections.</p> <p>Refer to "How to Clean Bill Acceptor" Or clean with bill reader cleaning card. (A5CC9000)</p> <p>Check wiring from bill acceptor to Main Board. (AACE8862)<br/>Repair or replace wiring harness.</p> <p>Check J8 connector on Main Board<br/>Make sure wires are secure in connectors.</p> <p>Refer to troubleshooting section of dollar bill acceptor manual included with this game or the diagnostics label on the back of the unit.</p> |
| <p><b>Game not coining up.</b></p>  | <p>Ensure game makes sound when coin switch is triggered.</p> <p>Game set to large amount of credits per game.</p>   | <p>Check coin switches—both should be wired normally open. If one switch is "closed" the other will not work either.</p> <p>Check wiring to main board.<br/>Cable AACBL4A-DOOR, AACE8850</p> <p>Jackpot display will show credits inserted.<br/>Enter N1 mode in menu to set credits per game.</p>   |

# TROUBLE SHOOTING GUIDE

| Problem   | Probable Cause   | Remedy   |
|---|--|--|
| <b>Scoring Issues</b><br><br><br>Encoder sensor not seeing wheel spin.   | Encoder sensor dirty or faulty.<br><br>Sensor is being interfered with.<br><br>Pinched, broken, or disconnected wiring.<br><br>Faulty Main Board | Clean sensor and replace if needed. (AACB8852)<br><br>Remove game from direct sunlight, move game to area away from neon lights or bright fluorescent lights.<br><br>Inspect wiring and replace cable if needed. AACB8852, AACE8851<br>Refer to Encoder Sensor Test below.   |
|   | Game says you won even though wheel is still spinning.   | Brake Assembly tension set to loose.<br><br>Refer to "How to Set Brake Tension"  |
|   | Wheel values, arrow pointer and payout are off slightly.   | There is an adjustment on the wheel encoder sensor to calibrate the monitor change to where the arrow is pointing.<br><br>Refer to "How to adjust wheel sensor"  |
| <b>Game is giving wrong tickets values.</b><br><br>Enter Diagnostic Menu on MENU 6 and watch dot matrix display as you spin the wheel downward.<br><br>*Remove game from direct sunlight, move game to area away from neon lights or bright fluorescent lights. | Wheel Position does <b>not</b> change as you spin the wheel down.  | Encoder sensor unplugged, dirty or faulty. Clean and replace if needed. (AACB8852)<br>Inspect wiring, refer to Encoder Sensor Test below.  |
|   | Wheel Position does change as you spin the wheel down.   | If Wheel Position goes to 24, then resets to 0 and continues up again.<br><br>Encoder sensor out of adjustment.<br>Refer to "How to adjust wheel sensor"   |
|   |  | If Wheel Position increments constantly upwards up past 100.<br><br>Home Position sensor unplugged, dirty or faulty.<br>Clean and replace if needed. (AACB4403)<br><br>Inspect wiring.<br>Cable #'s AACE8854, AACE8850<br><br>Wrong ticket pattern selected. Enter menu and go to MENU 2. Verify correct ticket pattern. |
| <b>Display shows "LOW TKTS"</b><br><br>  | Ticket tray is empty.<br><br>Disconnected, loose or broken wires.<br><br>Faulty low ticket switches.<br><br>Faulty Main Board.                   | Refill tray with tickets, check low ticket switch.<br><br>Check connections and reseal J25 on main board. Cable #'s AACE8852, AACE8853<br><br>Switches wired normally open. Replace switches. A5SW200<br><br>Replace main board. Part # AANEWGEN1  |

# TROUBLE SHOOTING GUIDE

| Problem   | Probable Cause  | Remedy  |   |   |   |  |  |
|---|---|---|---|---|---|--|--|
| <b>No Sound</b>   | Volume set to zero in menu.<br><br>Disconnected, loose or broken wires.<br><br>Faulty speaker.  | Enter N3 in menu for game volume.<br>Enter N4 in menu for attract volume.<br><br>Check connections and reseal J19 on main board. Cable # AACE8858<br><br>Replace speaker. AACE8811  |   |   |   |  |  |
| <b>Meters do not work.</b><br>Game meter will click at start of next game.<br><br>Ticket meter will click for every notch the dispenser "sees"  | Disconnected, loose or broken wires.<br><br>Faulty counters.  | Check connections and reseal J22 on main board. Cables # AACE8850 and AACO1000<br><br>Replace counters. AACO1000  |   |   |   |  |  |
| <b>Display not lighting up</b><br><br>Cycle game power off, wait 10 seconds, turn back on after checking connections.   | Phone cable to Display is bent, pinched or unplugged.<br><br>12 Volts DC to Display<br><br>Faulty Display Board.  | Inspect cable and sockets. Replace cable if needed. AACE8859<br><br>Verify 12 Volts DC to Display. Check and/or replace power supply if needed. AAPS1008<br><br>Replace Display Board. AACB8851   |   |   |   |  |  |
| <b>Tickets do not dispense or Wrong amount dispensed.</b><br><br><b>Check for the correct amount of tickets adding up on Display</b><br><br> | <table border="1" style="width: 100%; border-collapse: collapse;"> <tr> <td style="padding: 5px; vertical-align: top;">           Tickets Owed Display is adding up correctly         </td> <td style="padding: 5px;">           Opto-Sensor on ticket dispenser dirty.<br/>           Faulty ticket dispenser.<br/><br/>           Notch on tickets cut too shallow.<br/><br/>           Faulty cable. Disconnected, loose or broken wires.<br/><br/>           Faulty Main Board.         </td> <td style="padding: 5px;">           Blow dust from sensor and clean with isopropyl alcohol.<br/>           Replace with working dispenser to isolate the problem. (A5TD1)<br/>           Flip tickets and load upside-down to have large cut notch toward opto sensor.<br/>           Check connectors from ticket dispensers to main board. Check for continuity. Cables AACE8852, AACE8853<br/>           Replace main board.         </td> </tr> <tr> <td style="padding: 5px; vertical-align: top;">           Tickets Owed Display is <b>not</b> adding correctly         </td> <td style="padding: 5px;">           Game is scoring too soon – before wheel stops.<br/><br/>           Wrong ticket pattern selected.         </td> <td style="padding: 5px;">           Brake Assembly tension set to loose. Refer to "How to Set Brake Tension"<br/>           Enter menu and select MENU 6. Turn wheel downward and watch display. The display should match the wheel. If not, enter menu and select MENU 2. Verify game is set to correct ticket pattern.         </td> </tr> </table> | Tickets Owed Display is adding up correctly   | Opto-Sensor on ticket dispenser dirty.<br>Faulty ticket dispenser.<br><br>Notch on tickets cut too shallow.<br><br>Faulty cable. Disconnected, loose or broken wires.<br><br>Faulty Main Board. | Blow dust from sensor and clean with isopropyl alcohol.<br>Replace with working dispenser to isolate the problem. (A5TD1)<br>Flip tickets and load upside-down to have large cut notch toward opto sensor.<br>Check connectors from ticket dispensers to main board. Check for continuity. Cables AACE8852, AACE8853<br>Replace main board. | Tickets Owed Display is <b>not</b> adding correctly | Game is scoring too soon – before wheel stops.<br><br>Wrong ticket pattern selected. | Brake Assembly tension set to loose. Refer to "How to Set Brake Tension"<br>Enter menu and select MENU 6. Turn wheel downward and watch display. The display should match the wheel. If not, enter menu and select MENU 2. Verify game is set to correct ticket pattern. |
| Tickets Owed Display is adding up correctly   | Opto-Sensor on ticket dispenser dirty.<br>Faulty ticket dispenser.<br><br>Notch on tickets cut too shallow.<br><br>Faulty cable. Disconnected, loose or broken wires.<br><br>Faulty Main Board.   | Blow dust from sensor and clean with isopropyl alcohol.<br>Replace with working dispenser to isolate the problem. (A5TD1)<br>Flip tickets and load upside-down to have large cut notch toward opto sensor.<br>Check connectors from ticket dispensers to main board. Check for continuity. Cables AACE8852, AACE8853<br>Replace main board. |   |   |   |  |  |
| Tickets Owed Display is <b>not</b> adding correctly   | Game is scoring too soon – before wheel stops.<br><br>Wrong ticket pattern selected.  | Brake Assembly tension set to loose. Refer to "How to Set Brake Tension"<br>Enter menu and select MENU 6. Turn wheel downward and watch display. The display should match the wheel. If not, enter menu and select MENU 2. Verify game is set to correct ticket pattern.  |   |   |   |  |  |

# TROUBLE SHOOTING GUIDE

| Problem  | Probable Cause  | Remedy  |
|--|---|---|
| <p><b>Wheel not spinning when player moves handle.</b></p> <p>Check for 12 Volts DC at coin up on connector.</p>   | <p>No 12 Volts on connector at coin up.</p>   | <p>Inspect cable from Solenoid to main board. (J22) Cable part #'s: AACE8869, AACE8850</p> <p>Replace main board. (AANEWGEN1)</p>   |
| <p>Check for 12 Volts DC at coin up on connector.</p>  | <p>12 Volts present at connector, but solenoid still doesn't engage.</p>  | <p>Inspect cable as far into wheel as possible. Look for broken or stretched wires. Repair if possible.</p> <p>Wheel will have to be removed to further inspect or replace.<br/>Refer to "How to Remove Wheel"</p>  |
| <p><b>Solenoid always stays on.</b></p> <p>Players can continue to spin wheel after "good spin", allowing them to nudge it to the bonus space.</p> <p><b>Players will win a lot!</b></p> | <p>Jammed Solenoid or Springs</p> <p>Pinched Cable.</p> <p>Check for 12 Volts DC on cable to solenoid when game on, but not coined up in game play.</p> | <p>Inspect solenoid. Ensure it operates smoothly. Press in on silver bar. It is spring loaded and will spring back after release.</p> <p>Inspect cable for smashed wire. May also have to replace main board.</p> <p>If 12 Volts present, Replace main board. (AANEWGEN1)</p> <p>If no 12 Volts and solenoid is still engaged – Wheel will have to be removed to further inspect or replace.<br/>Refer to "How to Remove Wheel"</p> |

# POWER SUPPLY DIAGNOSTICS

Check power cable into back of game.

Check AC cord from power strip in game.

Verify power strip rocker switch is ON.  
(Switch cord into different socket in power strip)

Check AC connection to power supply.

Ensure Power Supply switch is set to 115V  
(Some power supplies may not have this)

Ensure Power switch is on.

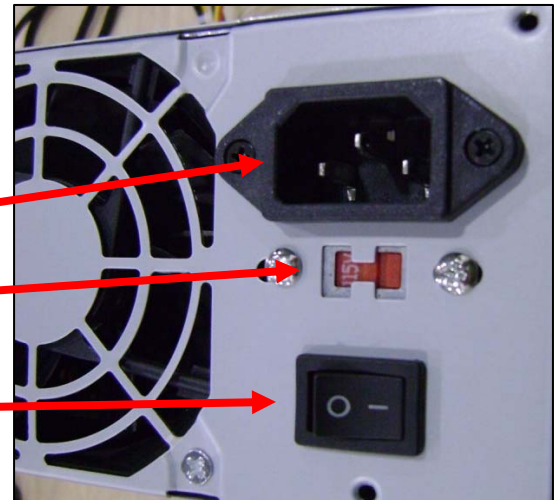

## Check if Power Supply Fan is turning:

If Fan is turning:  
Power supply is working. If game still has no 12 Volts DC, then Power Supply is faulty.  
Replace Power Supply. AAPS1008

If Fan is not turning:

Turn power OFF. Disconnect all 12 volt output wires from power supply only. Turn power ON.

Fan turns.

Fan does not turn

Replace Power Supply.  
(AAPS1008)

Turn power OFF. Unplug all outputs from the large PCB. Reconnect the 12 volt output wires from Power Supply to PCB main board. Turn power ON.

Fan turns.

Fan does not turn.

Short in PCB - Replace.

Turn power OFF. Reconnect the outputs at the PCB one at a time. Wait 60 seconds between tests to turn power ON.

Fan does not turn.

That cable or related component is shorted out or causing an overload. See Jumper Cable Pin-Outs to see which component might be at fault.

Fan turns.

That cable is OK.

# BILL ACCEPTOR DIAGNOSTICS

**Note: There are many different models and brands of Bill Acceptors that are used on redemption games. Your Bill Acceptor may differ from the unit shown.**

First determine if Bill Acceptor has power:

Turn game ON—The bill acceptor should make noise as stacker cycles and green lights on outside bezel should flash.

If NO power:

Due to the different models and brands of Bill Acceptors that are used: Examine Bill Acceptor and determine if acceptor is 12 Volt DC or 110 VAC Use meter to measure voltage at cable going into Bill Acceptor.

If power is OK:

Clean Bill Acceptor path to make sure there is nothing jamming unit.

Enter DBA Diagnostics Mode -

**Important—Do not hold button down too long or Bill Acceptor will enter programming mode.**

If accidentally entered programming mode by mistake—Unplug game and plug back in.



To enter Diagnostic Mode, press and hold the Diagnostic Button on the back left corner of the DBA for **1-3 seconds.**

The lights above the bill slot will flash the code.

## ERROR CODES

Count the number of flashes on front bezel of Bill Acceptor and follow chart for repair.

| FLASHING CODE                   | DESCRIPTION                                  | CORRECTIVE ACTION    |
|---------------------------------|--|----------------------|
| LEDs off                        | Power off                                    | Turn on power        |
| LEDs on                         | Acceptor is OK                               |                      |
| 1 flash                         | Bill path blockage                           | Un-jam bill path     |
| 2 flashes                       | Stacker jam                                  | Un-jam stacker       |
| 3 flashes                       | Cassette is full of bills                    | Empty the cassette   |
| 4 flashes                       | Cassette is removed                          | Replace the cassette |
| 5 flashes                       | Acceptor is defective                        | Replace the acceptor |
| 6 flashes                       | Acceptor not enabled                         | See service manual   |
| 10 flashes                      | Configuration Mode                           | Power down to exit   |
| Rapid flashing during operation | Stringing attempt detected; or sensors dirty | Clean the sensors    |





# HOW TO: Change Arrow Position

1. Slide open the cabinet window



2. Remove the nuts and washers from the 3 bolts shown and set aside

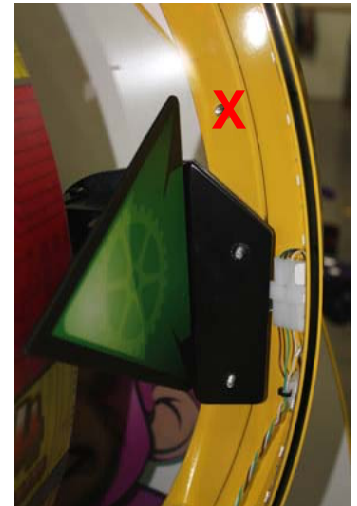

3. Move the entire arrow assembly down to the second set of bolts

4. Re-secure the lock nuts, adding a washer to the now-empty bolt



5. Close the window

6. Open the front door of the cabinet to access the main board

7. Turn dip switch 2 to the correct position (see page 7)

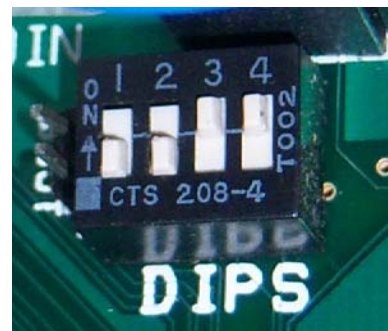

# HOW TO: Adjust Wheel Sensor

Wheel sensor is located behind the arrow on wheel.

It “reads” the notch in the side of the wheel to tell the game when the panel has changed.

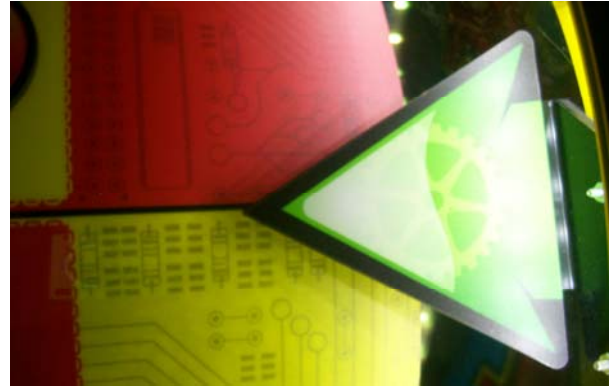

**Part #'s:**  
Pointer Assy. AAPO8800

## To Test:

Enter menu and go to MENU 2.

Spin Wheel slowly downward, and watch display's wheel position readout.

The wheel position value should change as soon as next panel crosses arrow point.



## To Adjust:

Turn Phillips head screw to move sensor.

Continue spinning wheel slowly downward, and watch display's wheel position readout; adjusting screw until panel changes at arrow.



# HOW TO: Set Brake Tension

## To Test:

Turn off game and flip dipswitch #4 ON.  
Turn game on.

The display will show "TEST BRAKE"

Use plunger handle to give the wheel a good spin, Let the wheel coast to a stop like a normal game play.

If brake is set correctly, screen will show a number between 50 - 70.

**If less than 50: Loosen Brake**

**If greater than 70: Tighten Brake**



## To Adjust:

### To loosen brake:

Loosen top nut and move 1/4 inch up. The threaded rod will drop as top nut moves up. Spin bottom nut up tight to bracket. Tighten both nuts.

### To tighten brake:

Loosen bottom nut and move 1/4 inch down. Lift up the threaded rod and spin nut down tight to bracket. Tighten both nuts.

**Re-test to verify.**

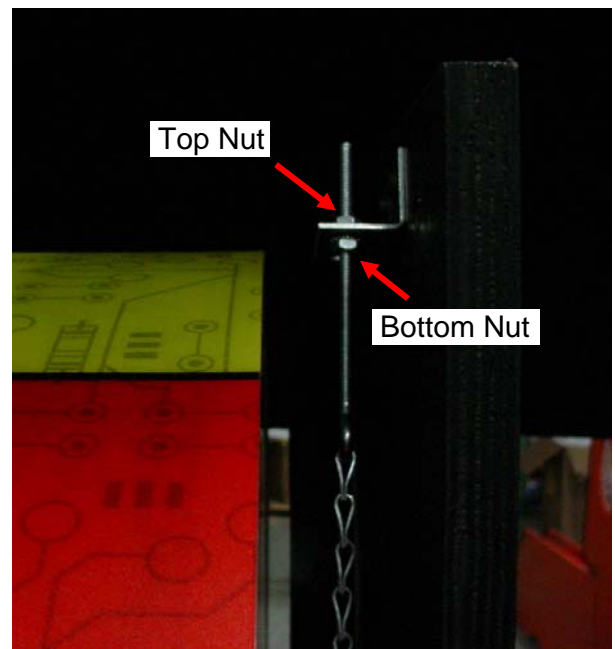

# HOW TO: Change Ticket Pattern



Slide up front plexi to access wheel by opening front door and unclipping 2 latches holding window bracket.

Push up on bracket, and roll plexi upwards.

Press Menu Button and go to MENU 6 Mode.

Slowly spin the wheel down while watching display.  
This number will match the number on the wheel.



Determine which ticket pattern to purchase:

Reference ticket patterns below—Note the approximate tickets per game for each pattern.

Purchase cover up decals.

| 1             | 2 default     | 3              | 4                | 5                 | 6                 | 7  | 8   | 9   | 10     | 11       | 12       |
|---------------|---------------|----------------|------------------|-------------------|-------------------|----|-----|-----|--------|----------|----------|
| 50c/250 bonus | 50c/500 bonus | 50c/1000 bonus | \$1.00/500 bonus | \$1.00/1000 bonus | \$1.00/2000 bonus |    |     |     | 1 Euro | 30 pence | 40 pence |
| 250           | 500           | 1000           | 500              | 1000              | 2000              | 50 | 100 | 100 | 1000   | 250      | 250      |
| 30            | 20            | 10             | 50               | 50                | 40                | 3  | 3   | 2   | 25     | 10       | 10       |
| 5             | 5             | 3              | 15               | 15                | 5                 | 5  | 5   | 4   | 100    | 3        | 3        |
| 10            | 10            | 5              | 25               | 20                | 10                | 3  | 3   | 2   | 50     | 5        | 5        |
| 100           | 100           | 50             | 250              | 100               | 50                | 20 | 20  | 20  | 250    | 50       | 100      |
| 30            | 20            | 10             | 40               | 50                | 25                | 3  | 3   | 2   | 25     | 10       | 10       |
| 5             | 5             | 3              | 15               | 15                | 5                 | 5  | 5   | 4   | 100    | 3        | 3        |
| 10            | 10            | 5              | 25               | 20                | 10                | 3  | 3   | 2   | 50     | 5        | 5        |
| 100           | 100           | 50             | 250              | 100               | 50                | 20 | 20  | 20  | 250    | 50       | 100      |
| 30            | 20            | 10             | 50               | 50                | 40                | 3  | 3   | 2   | 25     | 10       | 10       |
| 5             | 5             | 3              | 15               | 15                | 5                 | 5  | 5   | 4   | 100    | 3        | 3        |
| 10            | 10            | 5              | 25               | 20                | 10                | 3  | 3   | 2   | 50     | 5        | 5        |
| 100           | 100           | 50             | 250              | 100               | 50                | 20 | 20  | 20  | 250    | 50       | 100      |
| 30            | 20            | 10             | 40               | 50                | 25                | 3  | 3   | 2   | 25     | 10       | 10       |
| 5             | 5             | 3              | 15               | 15                | 5                 | 5  | 5   | 4   | 100    | 3        | 3        |
| 10            | 10            | 5              | 25               | 20                | 10                | 3  | 3   | 2   | 50     | 5        | 5        |

## Install cover up decals:

Press Menu Button and go to MENU 2 Mode.

Change number to desired Ticket Pattern as it shows on display.

Press Menu Button and go to MENU 6 Mode.

Spin wheel downward slowly one complete revolution

This number will show the new ticket value on the wheel.



Place new decal carefully over value on wheel.

**Note: Be careful to not rock wheel backwards over a notch, or the position will be off.**

**If it does rock backward, spin wheel downward one complete revolution to allow wheel to calibrate.**

Continue applying new decals carefully until wheel is complete.

# HOW TO: Remove Wheel

The wheel will have to be removed to access engaging solenoid to repair/replace.

## **Step 1:**

Remove the back door from the game using a 644 key.



## **Step 2:**

Remove the top back from the game. There are 4 screws on top of the game to remove. Inside the game there are 2 screws on the LEFT and 2 screws on the RIGHT to remove. (RIGHT side screws shown below) →

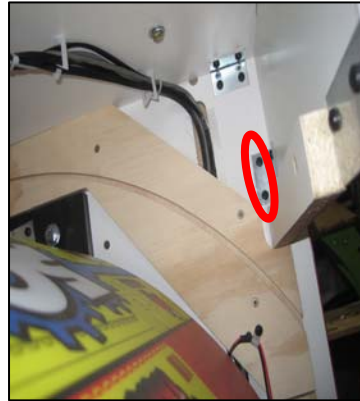

## **Step 3:**

Unplug the 8850-1 and the 8850-3 cables. Remove the 3 cable clamps from the board on the RIGHT side.



## **Step 4:**

Remove the screws from the upper and lower side boards from the LEFT and RIGHT side of the game. Remove the boards.

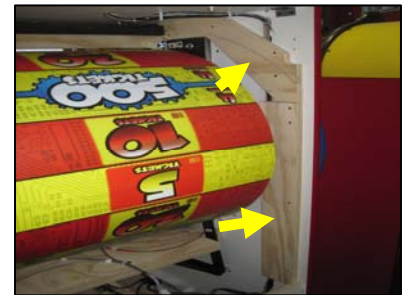

## **Step 5:**

Remove the pin from the linkage below the wheel on the RIGHT side. Separate the linkage after removing the pin.

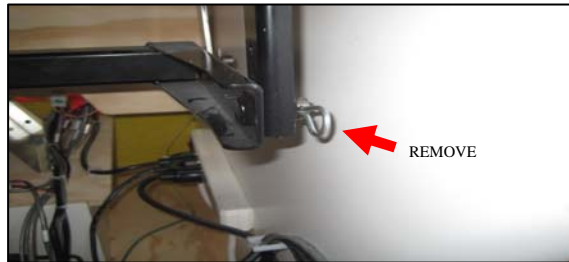

## **Step 6:**

Remove the upper and lower bolts from the sides of the wheel cradle.



# HOW TO: Remove Wheel, Cont.

## Step 7:

Move around to the front of the game and open the front door. Reach inside the game and unlatch both front window locks. Raise the window so you can easily access the arrow.

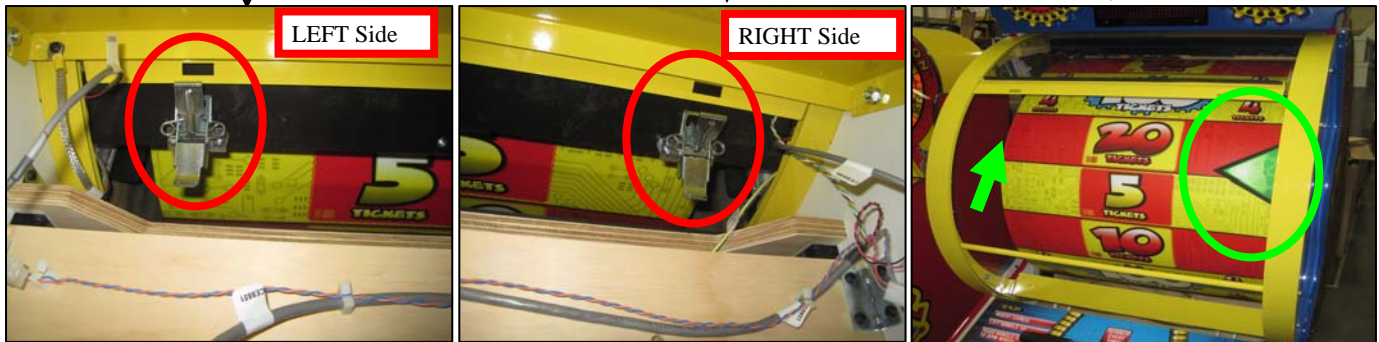

## Step 8:

Unplug the arrow sensor cable.  
Remove the 2 nuts from the arrow bracket.



## Step 9:

Remove the arrow assembly from the game. Be careful not to damage the sensor when removing the arrow.



## Step 10:

Close the front window.



## Step 11:

Move around to the back of the game.  
Begin to slide the wheel assembly straight back.  
When it gets about half way out, lean it back and lift it out of the game to remove.



# HOW TO: Clean Game

Use a mild soap solution and a clean lint free cloth to wipe down game.  
Do NOT use any cleaning solvents on the game's graphics!



Front Plexi will slide up. (Like a roll top desk)

## How to:

Open front door and unclip  
2 latches holding window  
bracket.



Push up on bracket, and roll plexi upwards.

Clean inside of plexi with lint free cloth or "swiffer"  
duster.

# PARTS LIST

| PART #    | DESCRIPTION                          | PART #        | DESCRIPTION                          |
|-----------|--------------------------------------|---------------|--------------------------------------|
| A5PL9097  | Plate, replaces the bill acceptor    | A5CORD5       | Cord, computer                       |
| AASO8800  | Wheel Engaging Solenoid              | A5FI9010      | Inline Filter                        |
| A5SW200   | Low Ticket Switch                    | AAGU4401      | Wire Guard                           |
| A5TD1     | Ticket Dispenser                     | A5LK2000      | Lock, 631password                    |
| A5TT4102  | Ticket Tray                          | A5LK5001      | Lock, 644                            |
| A5TU4400  | Clear Tubing                         | AASO4010      | Solenoid Assy for Wheel              |
| AAVF8800  | Blue Marquee with Decals             | AABK8801      | Bottom Front Bracket with Decal      |
| AAPS1008  | Power Supply                         | A5ME4180      | Metal, Right Ticket Tray             |
| A5DE8800  | Decal, Wheel, Front                  | A5ME4414-BLK  | Metal, Handle Guide                  |
| A5DE8801  | Decal, Pointer                       | A5ME4415      | Metal, T-Handle                      |
| A5DE8802  | Decal, Wheel Right Side              | A5ME8800      | Metal, Wheel Shaft                   |
| A5DE8803  | Decal, Wheel Left Side               | AABK8800      | Top Front Bracket with Decal         |
| A5DE8804  | Decal, Right Side Top                | A5ME8802      | Metal, Curved Glass Rail             |
| A5DE8805  | Decal, Left Side Top                 | AADO8800      | Front Door with Decal                |
| A5DE8806  | Decal, Right Side Middle             | AADO8801      | Coin Door with Decal                 |
| A5DE8807  | Decal, Left Side Middle              | A5ME8806      | Metal, Sliding Window Handle, Bigger |
| A5DE8808  | Decal, Right Side Bottom             | A5ME8807      | Metal, Sliding Window Bracket, Small |
| A5DE8809  | Decal, Left Side Bottom              | A5ME8810      | Metal, Handle Stop                   |
| A5DE8810  | Decal, Control Panel                 | A5ME8812      | Metal, Handle Rod for Pivot Assy     |
| A5DE8811  | Decal, Front top Door                | A5ME8813      | Metal, Window Brace                  |
| A5DE8812  | Decal, Bottom Front, around cash box | A5ME8814      | Metal, Side Guard on Bottom          |
| A5DE8813  | Decal, Coin Door                     | A5ME8816      | Metal, Rocker Arm                    |
| A5DE8814  | Decal, Marquee, Right Side           | AAPB2700      | Push Button with Cable               |
| A5DE8815  | Decal, Marquee, Left Side            | AACBLE4A-DOOR | Cable, Coin Door                     |
| A5DE8816  | Decal, Marquee, Center               | AACE1710      | Cable, Door Ground                   |
| A5DE8817  | Decal, Marquee Gear, Small           | AACE1715      | Cable, Ground Strap                  |
| A5DE8818  | Decal, Marquee Gear, Large Left      | AACE8811      | Speaker with Cable                   |
| A5DE8819  | Decal, Marquee Gear, Large Right     | AACE8850      | Cable, Main to Wheel                 |
| A5DE8821  | Decal, Seam                          | AACE8851      | Cable, Main Board to Menu Button     |
| A5DE8822  | Decal, Menu Options                  | AACE8852      | Cable, Ticket Tray                   |
| AADE8824  | Decal, Ticket Pattern #1             | AACE8853      | Cable, Mini Gen to Ticket Jumper     |
| AADE8825  | Decal, Ticket Pattern #2             | AACE8854      | Cable, Wheel Assy.                   |
| AADE8826  | Decal, Ticket Pattern #3             | AACE8855      | Cable, Power                         |
| AADE8827  | Decal, Ticket Pattern #4             | AACE8856      | Cable, Wheel Lights                  |
| AADE8828  | Decal, Ticket Pattern #5             | AACE8857      | Cable, Fluorescent Lights            |
| AADE8829  | Decal, Ticket Pattern #6             | AACE8858      | Cable, Speaker Cable                 |
| AADE8830  | Decal, Ticket Pattern #7             | AACE8859      | Cable, Matrix Main                   |
| AADE8831  | Decal, Ticket Pattern #8             | AACE8860      | Cable, Mini Gen to Marquee           |
| AACB4403  | Reflective Sensor                    | AACE8861      | Cable, Ground to Front Door          |
| AACB8850  | Circle Light                         | AACE8862      | Cable, DBA                           |
| AACB8851  | Dot Matrix                           | AACE8863      | Cable, Line Filter                   |
| AACB8852  | Encoder Sensor                       | AACE8864      | Cable, Half Moon Ground              |
| AACB8853  | Speaker Light                        | AACE8865      | Cable, Coin Door Ground              |
| AANEWGEN1 | Main Board                           | AACE8866      | Cable, Power Supply to Mini Gen      |
| A5BURU075 | Big Black Rubber Bumper              | AACE8867      | Cable, Marquee Jumper                |
| A5CB1499  | Cash Box                             | AACE8868      | Cable, Halogen                       |
| A5CO4400  | Handle Grips                         | AACE8869      | Cable, Solenoid                      |



# PARTS PICTURES



**AACB8852**



**AACB4403**



**AACB8851**



**AACB8853**



**AACB8850**



**AASO8800**



**A5TD1**



**AANEWGEN1**



**AAPS1008**



**A5PL9097**



**A5ME8806**

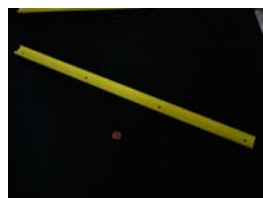

**A5ME8807**



**A5ME8802**



**A5ME8800**

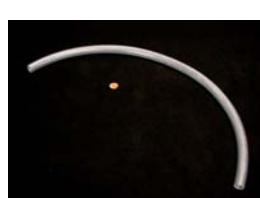

**A5TU4400**



**A5ME8816**



**A5ME8814**



**A5ME8813**



**A5ME8812**



**A5ME8810**



**A5LK2000**



**A5LK5001**



**A5FI9010**



**A5SW200**



**A5CORD5**



**AADO8800**



**AADO8801**



**AAVF8800**



**AABK8800**

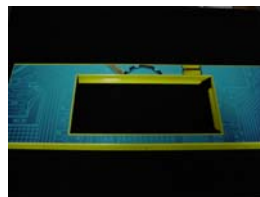

**AABK8801**



**A5CO4400**



**A5CB1499**



**A5BURU075**

# PARTS PICTURES



**AACBL4A-DOOR**



**AACE1710**



**AACE1715**



**AACE8811**



**AACE8850**

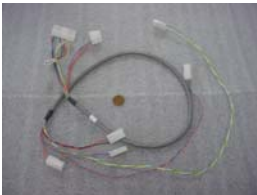

**AACE8851**



**AACE8852**



**AACE8853**

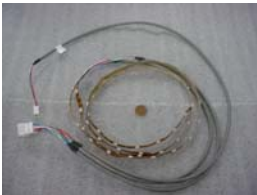

**AACE8854**



**AACE8855**

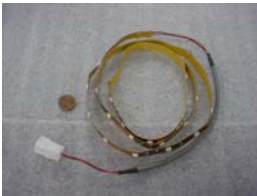

**AACE8856**



**AACE8857**



**AACE8858**



**AACE8859**



**AACE8860**



**AACE8861**



**AACE8862**



**AACE8863**



**AACE8865**



**AACE8866**



**AACE8867**



**AAPB2700**

# DECAL PLACEMENT

## Crank It! - Decal Diagram

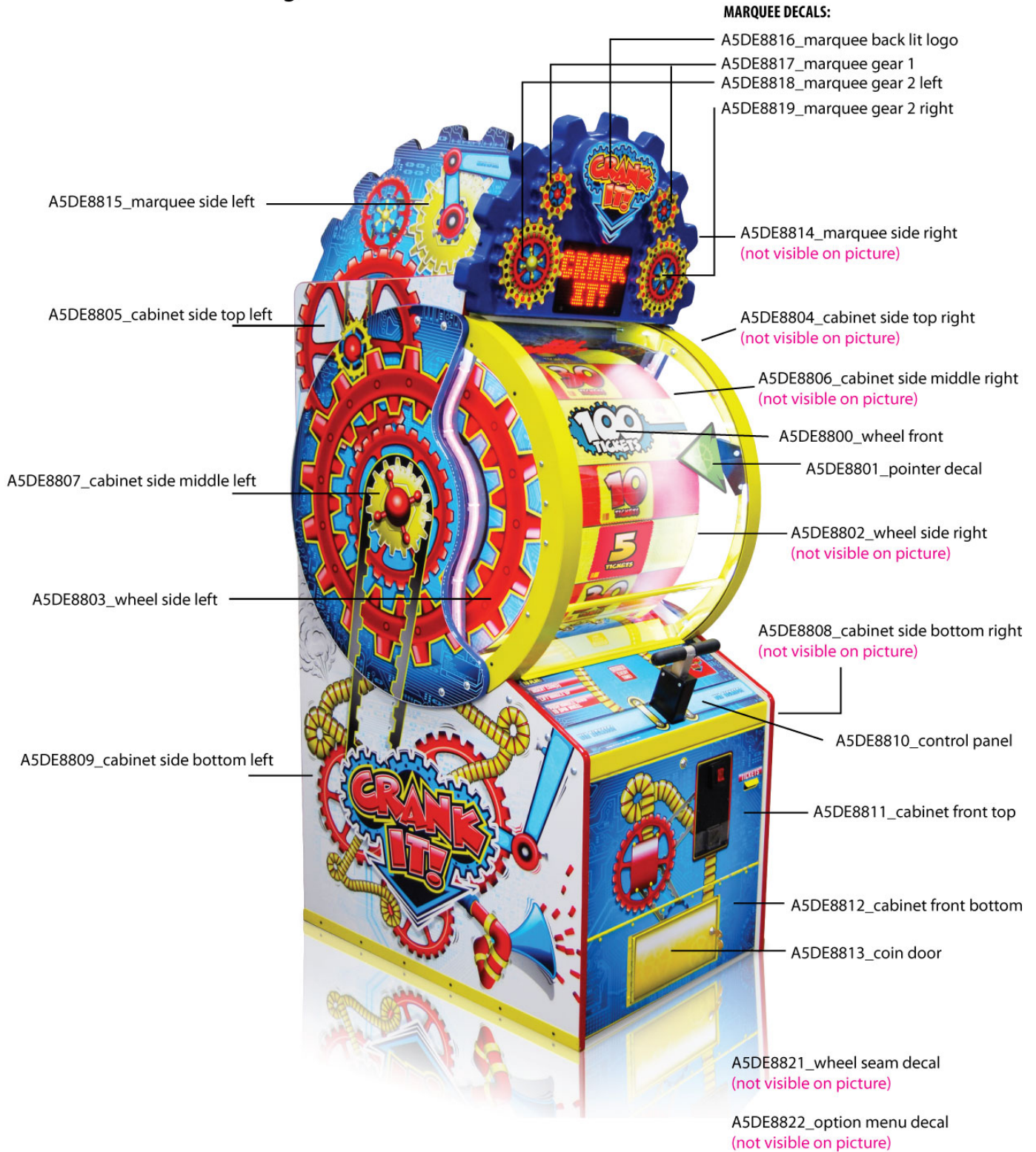

# MAINBOARD PINOUT

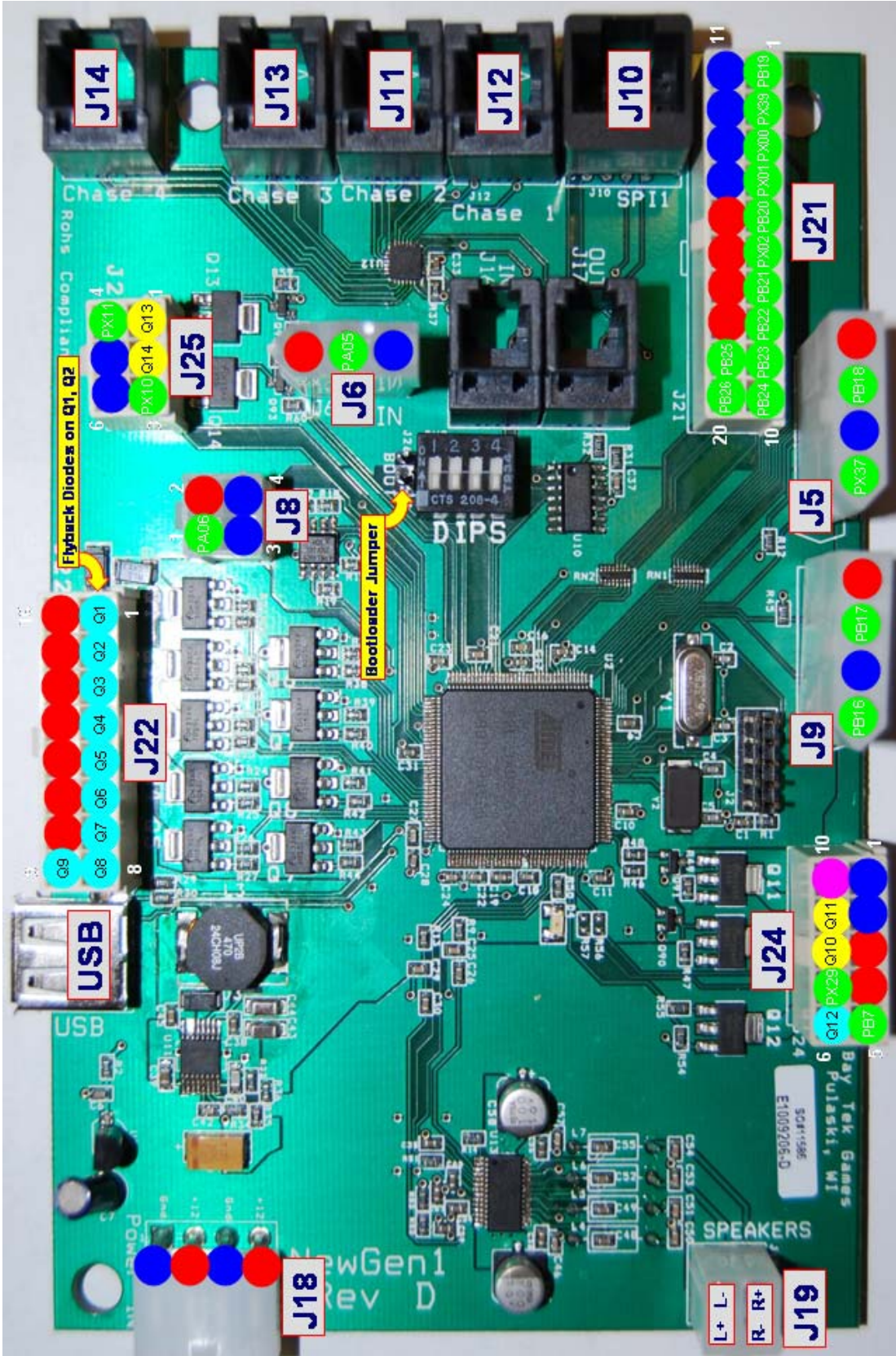

- Ground
  - +12V
  - Low Side Driver
  - High Side Driver
  - +3.3V TTL Logic
  - +3.3V
- 
- SPI Out - Display - (J10)
    - Pin 1 & Pin 3 - +12V
    - Pin 2 - SCLK\_BUS2
    - Pin 4 - SMOSI\_BUS2
    - Pin 5 & Pin 7 - Ground
    - Pin 6 - SCS2\_BUS2
    - Pin 8 - SMISO\_BUS2
  - Chase Lights (J11, J12, J13, J14)
    - Pin 1 - Chase Output
    - Pin 2 - Chase Output
    - Pin 3 - +12V
    - Pin 4 - Chase Output
    - Pin 5 - Chase Output
    - Pin 6 - +12V

# MAINBOARD PINOUT GUIDE

## BayTek Crank IT NEWGEN1 Hardware REV D Pinout - Version 1

|                            |
|----------------------------|
| Low Side Driver            |
| High Side Driver           |
| TTL Input/Output           |
| LED Constant Current Drive |
| +12 Volts                  |
| Ground                     |

| Pin Type            | Purpose               | Ref | Pin # |
|---------------------|-----------------------|-----|-------|
| LOWSIDE #1, w diode | Solenoid              | J22 | 1     |
| LOWSIDE #2, w diode |                       | J22 | 2     |
| LOWSIDE #3          | RED RGB               | J22 | 3     |
| LOWSIDE #4          | BLUE RGB              | J22 | 4     |
| LOWSIDE #5          | GREEN RGB             | J22 | 5     |
| LOWSIDE #6          |                       | J22 | 6     |
| LOWSIDE #7          |                       | J22 | 7     |
| LOWSIDE #8          | Mechanical Counter #1 | J22 | 8     |
| LOWSIDE #9          | Mechanical Counter #2 | J22 | 9     |
| +12 Volts           |                       | J22 | 11    |
| +12 Volts           |                       | J22 | 12    |
| +12 Volts           |                       | J22 | 13    |
| +12 Volts           |                       | J22 | 14    |
| +12 Volts           |                       | J22 | 15    |
| +12 Volts           |                       | J22 | 16    |
| +12 Volts           |                       | J22 | 17    |
| +12 Volts           |                       | J22 | 18    |
| +12 Volts           |                       | J22 | 19    |
| +12 Volts           |                       | J22 | 20    |

| Pin Type     | Purpose              | Ref | Pin # |
|--------------|----------------------|-----|-------|
| Ground       |                      | J24 | 1     |
| Ground       |                      | J24 | 2     |
| +12 Volts    |                      | J24 | 3     |
| +12 Volts    |                      | J24 | 4     |
| PB7          |                      | J24 | 5     |
| LOWSIDE #12  | Ambient White Lights | J24 | 6     |
| PX29         |                      | J24 | 7     |
| HIGHSIDE #10 |                      | J24 | 8     |
| HIGHSIDE #11 |                      | J24 | 9     |
| 3.3V         |                      | J24 | 10    |

|           |                             |    |   |
|-----------|-----------------------------|----|---|
| PX37      | Ticket Notch #1             | J5 | 1 |
| Ground    | Ground for Ticket Dispensor | J5 | 2 |
| PB18      | Ticket Motor #1             | J5 | 3 |
| +12 Volts | Power for Ticket Dispensor  | J5 | 4 |

|           |  |    |   |
|-----------|--|----|---|
| PB16      |  | J9 | 1 |
| Ground    |  | J9 | 2 |
| PB17      |  | J9 | 3 |
| +12 Volts |  | J9 | 4 |

|           |           |    |   |
|-----------|-----------|----|---|
| PA06      | DBA Input | J8 | 1 |
| +12 Volts |           | J8 | 2 |
| Ground    |           | J8 | 3 |
| Ground    |           | J8 | 4 |

|              |                  |     |   |
|--------------|------------------|-----|---|
| HIGHSIDE #13 |                  | J25 | 1 |
| HIGHSIDE #14 |                  | J25 | 2 |
| PX10         | Low Ticket Input | J25 | 3 |
| PX11         |                  | J25 | 4 |
| Ground       |                  | J25 | 5 |
| Ground       |                  | J25 | 6 |

|           |                 |    |   |
|-----------|-----------------|----|---|
| +12 Volts | Coin Door Power | J6 | 1 |
| PA05      | Coin Input      | J6 | 2 |
| Ground    | Coin Ground     | J6 | 3 |

# MAINBOARD PINOUT GUIDE

|           |                       |     |    |           |     |   |
|-----------|-----------------------|-----|----|-----------|-----|---|
| PB19      | Service Button #1     | J21 | 1  | Driver 1  | J12 | 1 |
| PX39      |                       | J21 | 2  | Driver 2  | J12 | 2 |
| PX00      | Service Button #2     | J21 | 3  | +12 Volts | J12 | 3 |
| PX01      |                       | J21 | 4  | Driver 3  | J12 | 4 |
| PB20      |                       | J21 | 5  | Driver 4  | J12 | 5 |
| PX02      |                       | J21 | 6  | +12 Volts | J12 | 6 |
| PB21      |                       | J21 | 7  |           |     |   |
| PB22      | Wheel Sensor Input #1 | J21 | 8  | Driver 5  | J11 | 1 |
| PB23      | Wheel Sensor Input #2 | J21 | 9  | Driver 6  | J11 | 2 |
| PB24      |                       | J21 | 10 | +12 Volts | J11 | 3 |
| Ground    |                       | J21 | 11 | Driver 7  | J11 | 4 |
| Ground    |                       | J21 | 12 | Driver 8  | J11 | 5 |
| Ground    |                       | J21 | 13 | +12 Volts | J11 | 6 |
| Ground    |                       | J21 | 14 |           |     |   |
| +12 Volts |                       | J21 | 15 | Driver 9  | J13 | 1 |
| +12 Volts |                       | J21 | 16 | Driver 10 | J13 | 2 |
| +12 Volts |                       | J21 | 17 | +12 Volts | J13 | 3 |
| +12 Volts |                       | J21 | 18 | Driver 11 | J13 | 4 |
| PB25      |                       | J21 | 19 | Driver 12 | J13 | 5 |
| PB26      |                       | J21 | 20 | +12 Volts | J13 | 6 |
|           |                       |     |    |           |     |   |
|           |                       |     |    | Driver 13 | J14 | 1 |
|           |                       |     |    | Driver 14 | J14 | 2 |
|           |                       |     |    | +12 Volts | J14 | 3 |
|           |                       |     |    | Driver 15 | J14 | 4 |
|           |                       |     |    | Driver 16 | J14 | 5 |
|           |                       |     |    | +12 Volts | J14 | 6 |

# MAINTENANCE LOG

If you need to make repairs or order replacement parts, it is a good idea to keep a log. Below is a chart you can use to track repairs and maintenance.

| DATE | MAINTENANCE PERFORMED | PARTS ORDERED | INITIALS |
|------|-----------------------|---------------|----------|
|      |                       |               |          |
|      |                       |               |          |
|      |                       |               |          |
|      |                       |               |          |
|      |                       |               |          |
|      |                       |               |          |
|      |                       |               |          |
|      |                       |               |          |
|      |                       |               |          |
|      |                       |               |          |
|      |                       |               |          |
|      |                       |               |          |
|      |                       |               |          |
|      |                       |               |          |
|      |                       |               |          |
|      |                       |               |          |
|      |                       |               |          |
|      |                       |               |          |
|      |                       |               |          |
|      |                       |               |          |
|      |                       |               |          |
|      |                       |               |          |
|      |                       |               |          |
|      |                       |               |          |
|      |                       |               |          |
|      |                       |               |          |
|      |                       |               |          |
|      |                       |               |          |
|      |                       |               |          |
|      |                       |               |          |
|      |                       |               |          |
|      |                       |               |          |
|      |                       |               |          |
|      |                       |               |          |
|      |                       |               |          |
|      |                       |               |          |
|      |                       |               |          |
|      |                       |               |          |
|      |                       |               |          |
|      |                       |               |          |
|      |                       |               |          |
|      |                       |               |          |
|      |                       |               |          |
|      |                       |               |          |
|      |                       |               |          |
|      |                       |               |          |
|      |                       |               |          |
|      |                       |               |          |
|      |                       |               |          |
|      |                       |               |          |
|      |                       |               |          |

# TECHNICAL SUPPORT

Excellent customer service is very important to Bay Tek Games! We know that keeping your games in great operating condition is important to your business. When you need us, we are here to help.

You can call us for free technical assistance, and you can count on us to have parts on-hand to support your game. When you do need us, it's important that you know what to expect. We offer options that fit your needs.

## Electronics / Circuit Boards - Repair Options

**Repair & Return** – If you have Circuit Board issues with your Bay Tek game, you can send the board to us and we'll repair it right away. Most items sent to us are repaired and returned to you within two days. This option is your best value as we offer this fast turn-around service at the most reasonable price.

**Advance Replacement** – If you have Circuit Board issues with your Bay Tek game, but you don't have time to send in your board in for repair, give us a call and ask for an Advance Replacement. We'll send you a replacement board that same day (pending availability). When you get your new board, just repackage the defective board in the same box and send it back to us. We make it easy by including a UPS Return Shipping label for you to put on the box (not available for international shipments). This is your best option when you need to get you game up and running as quickly as possible!

**Spare Parts** – Take matters into your own hands and purchase new spare Circuit Boards for your Bay Tek games. Many of our games share the same main-board electronics. This means you can buy one set of spare electronics to support many of your Bay Tek games. Spare boards allow you to get your game up and running the quickest and provide you a valuable troubleshooting option. Call our technicians to get recommendations for what you should keep on hand for spare parts!

## Technical Support:

"You" are the best tool for troubleshooting! Your abilities to understand the game and your skills to repair the game are invaluable to us! If you need help, you know you can call us. It's not easy to diagnose a game remotely by phone, but our technicians do a great job. They'll need your help to perform some troubleshooting steps and convey to them exactly what's happening with your game.

## Returns, Credits, & Fees:

**NOTICE!** ALL ITEMS being sent to Bay Tek Games for repair or return, etc. require prior Return Authorization! Bay Tek Games will provide a Product Return Form with an authorizing Ticket Number for each item to be returned. Please be certain to include this document with all shipments!

**Late Fees and Non-Return Fees** - Advance Replacement and Warranty Replacement items require the defective items to be returned by Bay Tek games promptly to avoid Late Fees. We would expect items to be returned within 10 working days. Late fees are invoiced monthly. Late fees are non-refundable under any circumstance! Any item not returned within 90 days will be invoiced in full as a replacement part!

**Bench Fees** - Bench fees will apply for each electronic item returned to Bay Tek Games (this includes unused Advance Replacement items). This charge covers our cost to inspect, evaluate and retest each item. Please note that returned items that do not pass our tests will be charged accordingly as replacement items or advance replacements.

**Restocking Fees** - Unused items returned for credit will be credited minus a restocking fee. Items must be returned within 30 days of purchase in order to qualify for any credit amount. No shipping charges will be credited.





# WARRANTY



Bay Tek Games warrants to the original purchaser that all game components will be free of defects in workmanship and materials for a period of 6 months from the date of purchase. If you fill out the registration card in the cashbox of the game, Bay Tek will add another 3 months to your warranty, free of charge.

Bay Tek Games will, without charge, repair or replace defective component parts upon notification to the parts/service department while the game is under warranty.

Warranty replacement parts will be shipped immediately, via ground service, along with a Product Return Form for the return of defective parts.

Defective parts must be shipped back to Bay Tek Games unless otherwise instructed. Items not returned to Bay Tek Games will be invoiced as replacement parts.

This warranty does not apply in the event of any misuse or abuse to the product, or as a result of any unauthorized repairs or alterations. The warranty does not apply if any serial number decal is altered, defaced, or removed from its original position.

|   |                  |   |
|---|------------------|---|
|    | <b>ATTENTION</b> |  |
| In order to maintain the safety & other compliance certifications of the game, ONLY approved parts may be used. For approved parts, refer to the parts list in this manual. |                  |   |

Should you need your game serviced, determine the serial number from the decal placed on the front of this manual, or locate it on the back of the game. Then contact our Service Department at: 920.822.3951 or e-mail: [service@baytekgames.com](mailto:service@baytekgames.com)

# NON-WARRANTY

Options and estimated charges will be provided to you for your approval. Please remember that any items being sent to Bay Tek Games must include prior return authorization from our Parts & Service Department. This approval will include a Product Return Form which is required to be included with any incoming shipments. Repaired parts will be shipped back using the same method in which they were received. Repairs are warranted for 30 days from the date of return shipment.

# CERTIFICATE OF COMPLIANCE



## Declaration of Conformity

| Manufacturer Identification  | Equipment Identification   |
|--|--|
| <p><b>Bay Tek Games, Inc.</b><br/>                     1077 East Glenbrook Drive<br/>                     Pulaski, WI 54162<br/>                     U.S.A.<br/> <a href="http://www.baytekgames.com">http://www.baytekgames.com</a></p> | <p><b>Crunk It!</b><br/>                     Model:    ΔAGM-CI-220V<br/>                                 ΔAGM-CI-220V-CEC</p> <p style="text-align: right;">Type:                      Redemption Game</p> |

| Council Directive 2004/108/EC   | Electromagnetic Compatibility  |                |                     |                |   |     |                      |                   |                      |     |                                |       |                      |                    |                      |                           |                       |
|---|--------------------------------|----------------|---------------------|----------------|---|-----|----------------------|-------------------|----------------------|-----|--------------------------------|-------|----------------------|--------------------|----------------------|---------------------------|-----------------------|
| <p><b>Emissions Standard:</b><br/>                     EN 55014-1: 2006 + A1:2009 + A2:2011</p> <table border="1" style="width: 100%; border-collapse: collapse;"> <tr> <td style="width: 30%;">Terminal Disturbance Voltage</td> <td>150kHz - 30MHz</td> </tr> <tr> <td>Discontinuous Power</td> <td>30MHz - 300MHz</td> </tr> </table> <p><b>Emissions Standards:</b><br/>                     EN 61000-3-2:2006 + A1:2009 + A2:2009 Current Harmonics<br/>                     EN 61000-3-3:2008 Voltage Flicker</p> | Terminal Disturbance Voltage   | 150kHz - 30MHz | Discontinuous Power | 30MHz - 300MHz | <p><b>Immunity Standards:</b><br/>                     EN 55014-2: 1997 + A1:2001 + A2:2008</p> <table border="1" style="width: 100%; border-collapse: collapse;"> <tr> <td style="width: 30%;">ESD</td> <td>IEC61000-4-2:2008-12</td> </tr> <tr> <td>Radiated Immunity</td> <td>IEC61000-4-3:2006-02</td> </tr> <tr> <td>EFT</td> <td>IEC61000-4-4:2004-07 + A1:2010</td> </tr> <tr> <td>Surge</td> <td>IEC61000-4-5:2005-11</td> </tr> <tr> <td>Contacted Immunity</td> <td>IEC61000-4-6:2008-10</td> </tr> <tr> <td>Power Dips and Interrupts</td> <td>IEC61000-4-11:2004-03</td> </tr> </table> | ESD | IEC61000-4-2:2008-12 | Radiated Immunity | IEC61000-4-3:2006-02 | EFT | IEC61000-4-4:2004-07 + A1:2010 | Surge | IEC61000-4-5:2005-11 | Contacted Immunity | IEC61000-4-6:2008-10 | Power Dips and Interrupts | IEC61000-4-11:2004-03 |
| Terminal Disturbance Voltage  | 150kHz - 30MHz                 |                |                     |                |   |     |                      |                   |                      |     |                                |       |                      |                    |                      |                           |                       |
| Discontinuous Power   | 30MHz - 300MHz                 |                |                     |                |   |     |                      |                   |                      |     |                                |       |                      |                    |                      |                           |                       |
| ESD   | IEC61000-4-2:2008-12           |                |                     |                |   |     |                      |                   |                      |     |                                |       |                      |                    |                      |                           |                       |
| Radiated Immunity   | IEC61000-4-3:2006-02           |                |                     |                |   |     |                      |                   |                      |     |                                |       |                      |                    |                      |                           |                       |
| EFT   | IEC61000-4-4:2004-07 + A1:2010 |                |                     |                |   |     |                      |                   |                      |     |                                |       |                      |                    |                      |                           |                       |
| Surge   | IEC61000-4-5:2005-11           |                |                     |                |   |     |                      |                   |                      |     |                                |       |                      |                    |                      |                           |                       |
| Contacted Immunity  | IEC61000-4-6:2008-10           |                |                     |                |   |     |                      |                   |                      |     |                                |       |                      |                    |                      |                           |                       |
| Power Dips and Interrupts   | IEC61000-4-11:2004-03          |                |                     |                |   |     |                      |                   |                      |     |                                |       |                      |                    |                      |                           |                       |

| Council Directive 2006/95/EC   | Low Voltage |
|--|-------------|
| <p><b>Standards:</b><br/>                     Household and similar electrical appliances - Safety - Part 1: General requirements, IEC 60335-1:2001 (4th Edition) (incl. Corrigendum 1:2002) +A1:2004 +A2:2006 (incl. Corrigendum 1:2006), and Part 2: Particular requirements for amusement machines and personal service machines, IEC 60335-2-82:2002 (2nd edition) +A1:2008<br/>                     With differences according to EN 62233:2008</p> |             |

I hereby declare, on behalf of the manufacturer above, that the equipment listed meets the requirements of all applicable Council Directives for CE Marking. Conformance was demonstrated by meeting the requirements of the referenced harmonized Standards.

| Name  | Title     | Signature                  | Date      |
|---|-----------|----------------------------|-----------|
| Gactan Philippon  | President | <i>Gactan J. Philippon</i> | 8-31-2012 |
| Email: <a href="mailto:gphilippon@baytekgames.com">gphilippon@baytekgames.com</a> |           | Phone: 920-822-3951        |           |

Document Number: 04262011.1



passion in ★ fun out